

PART NUMBER	DESCRIPTION
CCRT-33S	Commercial Latching SPDT, DC-18GHz, Internal 50Ω Termination
CRT-33S	Elite Latching SPDT, DC-22GHz, Internal 50Ω Termination

The CCRT-33S/CRT-33S is an internally terminated, broadband, SPDT, electromechanical coaxial switch designed to switch a microwave signal from a common input to either of two outputs. The characteristic impedance is 50 Ohms. Internal terminations provide an impedance match for the unselected port. The switches are small with the minimum spacing that is compatible with SMA connectors.



ENVIRONMENTAL AND PHYSICAL CHARACTERISTICS	
Operating Temperature	
Commercial Model, CCRT-33S	-40°C to 65°C
Elite Model, CRT-33S***	-55°C to 85°C
Vibration (MIL-STD-202 Method 214, Condition D, non-operating)	10 g's RMS
Shock (MIL-STD-202 Method 213, Condition D, non-operating)	500 g's
Standard Actuator Life	5,000,000 cycles
Actuator Life w/ Additional Features	1,000,000 cycles
Connector Type	SMA
Humidity (Moisture Seal)	Available
Weight	2.65 oz. (75.13g) (max.)

ELECTRICAL CHARACTERISTICS	
Form Factor	SPDT, break before make
Frequency Range	
CCRT-33S	DC–18 GHz
CRT-33S	DC–22 GHz
Characteristic Impedance	50 Ohms
Terminations	50Ω, 2 Watts CW max.
Operate Time	10 ms (max.)
Release Time	10 ms (max.)
Actuation Voltage Available	12 15 24 28 V
Actuation Current, max. @ ambient	420 350 280 200 mA

TYPICAL PERFORMANCE CHARACTERISTICS				
Frequency	DC–6 GHz	6–12 GHz	12–18 GHz	18–22 GHz
Insertion Loss, dB, typical.	0.2	0.3	0.4	0.5
Isolation, dB, typical.	80	75	70	70
VSWR, typical.	1.1:1	1.2:1	1.3:1	1.5:1

For maximum limits, please see charts on page 3-5

PART NUMBERING SYSTEM

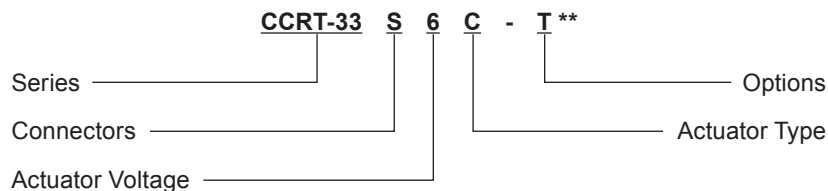

Connector
S: SMA Female

Actuator Voltage
6: 28 Vdc Latching
7: 15 Vdc Latching
8: 12 Vdc Latching
9: 24 Vdc Latching

Actuator Type
0: Standard Contacts
C: Indicator Contacts***
D: Self Cutoff Only
E: Indicators and Self Cutoff***

***SEE PARTS LIST ON PAGE 8

Options
T: TTL Drivers with Diodes
D: Transient Suppression Diodes
R: Positive + Common
M: Moisture Seal
S: 9 Pin D-Sub Connector

For other options, contact factory.

*** Indicator Contacts Operating Temperature
-50°C to 85°C (Elite Model Only)

Series CCRT-33S/CRT-33S

Internal 50Ω Termination DC-18 GHz/DC-22 GHz
Latching SPDT Coaxial Switch



SCHEMATICS AND MECHANICAL OUTLINE

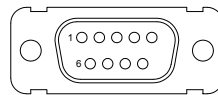
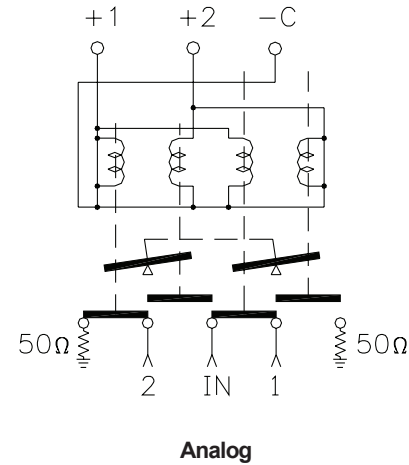
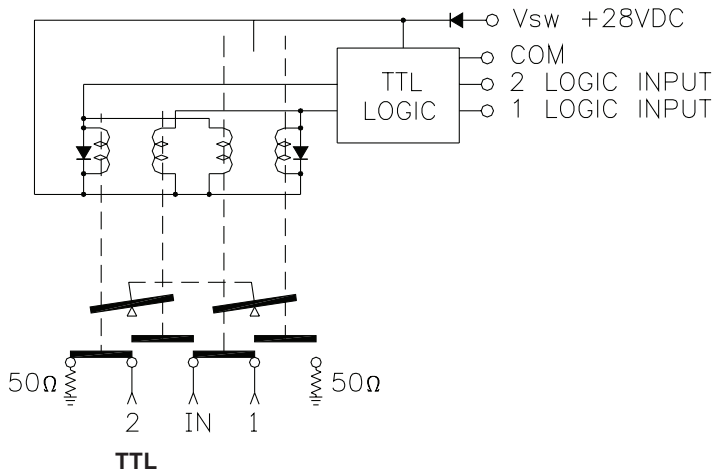
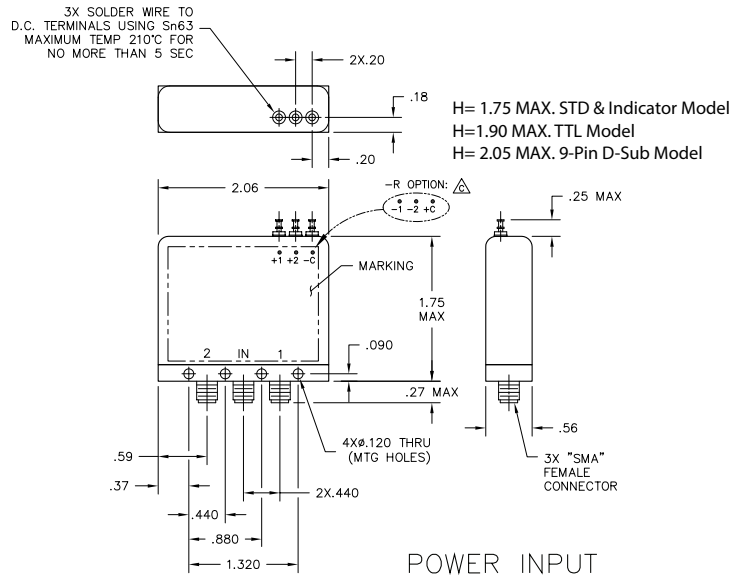
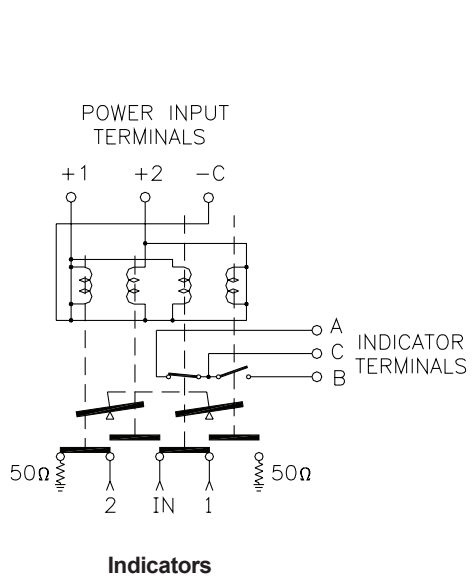

“-S OPTION” 9-PIN D-SUB CONNECTOR (EXAMPLE: CCRT-33S60-S)

9 PIN D-SUB PINOUT FOR LATCHING SPDT				
Pin No.	OPTIONS			
	Basic	Indicators	TTL	Indicators & TTL
1	1	1		
2	2	2		
3	C	C	Common	Common
4			1	1
5			2	2
6			Vsw	Vsw
7		A		A
8		B		B
9		C		C

TRUTH TABLE (with TTL option)					
Logic Input		RF Path		Indicator (if applicable)	
1	2	IN to 1	IN to 2	A	B
0	0	No Change			
1	0	On Terminated		C	0
0	1	Terminated On		0	C
1	1	Forbidden			

TYPICAL NARROWBAND RF INSERTION LOSS PERFORMANCE CURVES

Insertion Loss (DC-6 GHz)

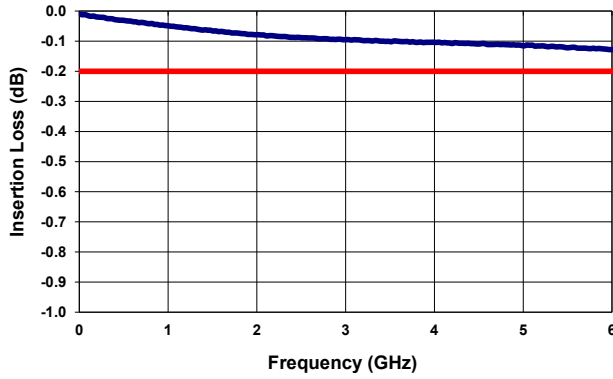

Insertion Loss (6-12 GHz)

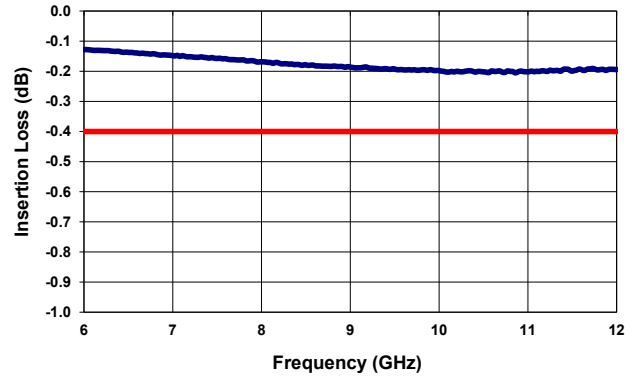

Insertion Loss (12-18 GHz)

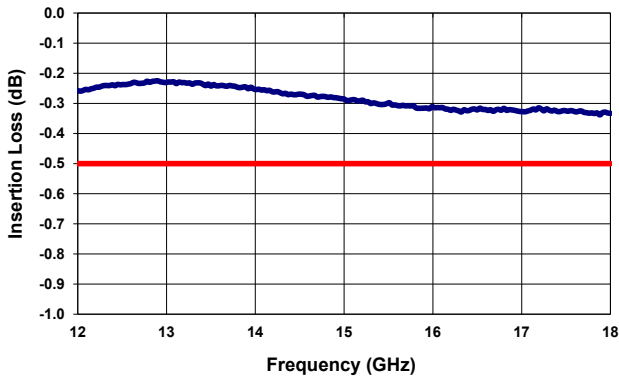

Insertion Loss (18-22 GHz)

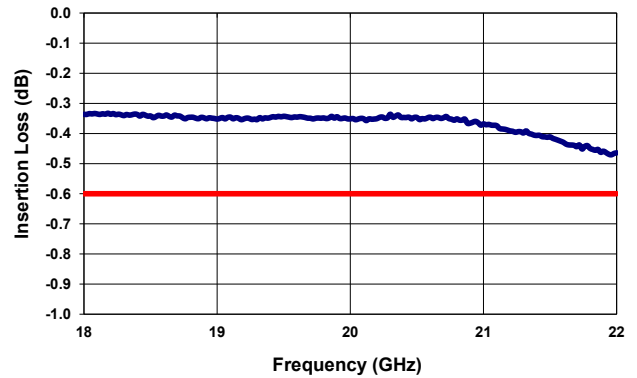

ELITE MODEL ONLY

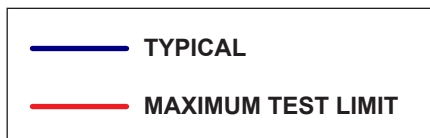

TYPICAL NARROWBAND RF ISOLATION PERFORMANCE CURVES

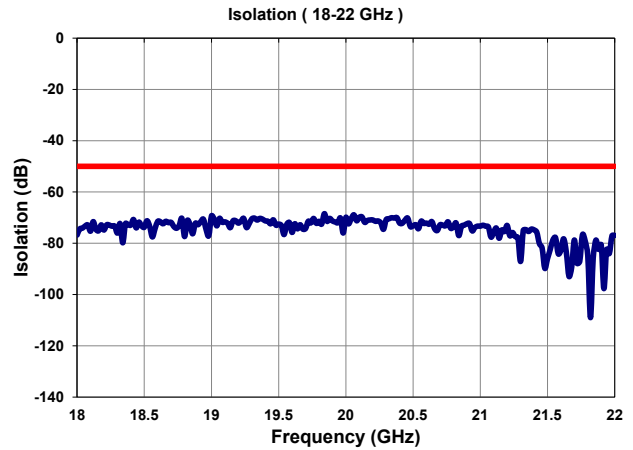
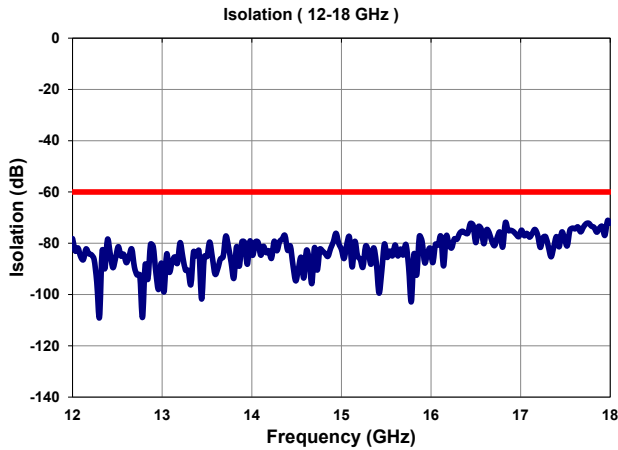
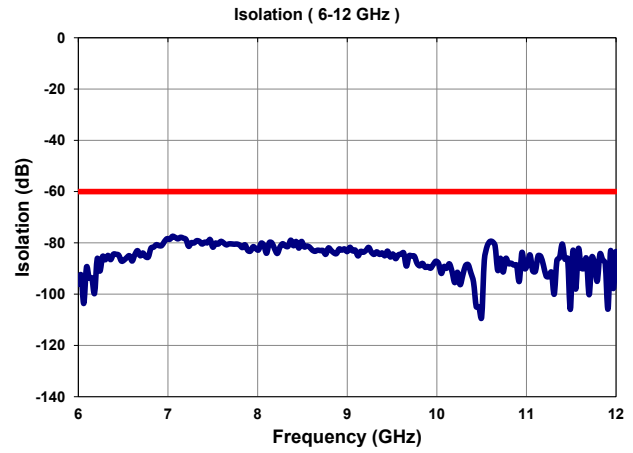
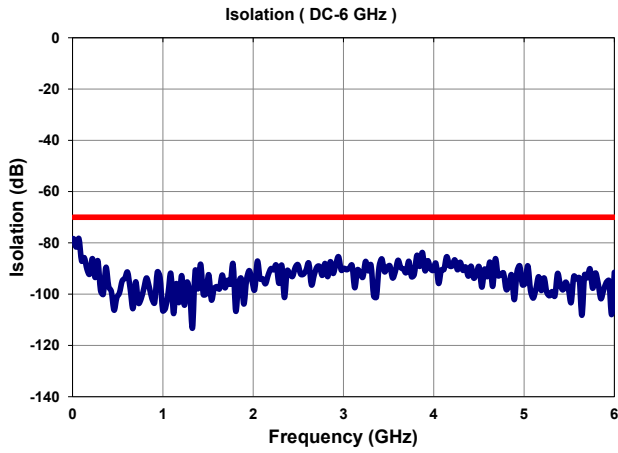

ELITE MODEL ONLY

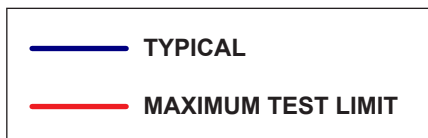

TYPICAL NARROWBAND RF VSWR PERFORMANCE CURVES

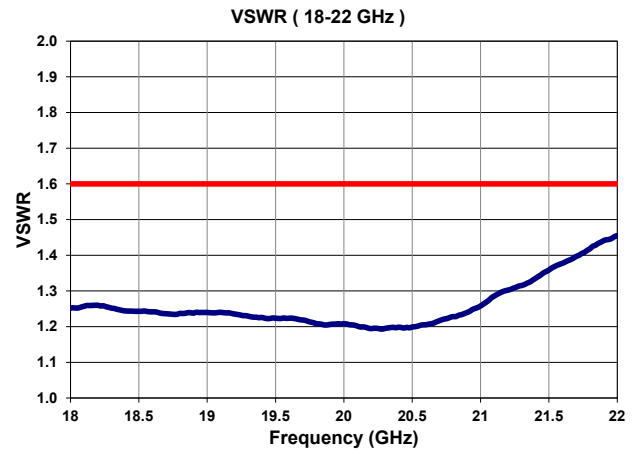
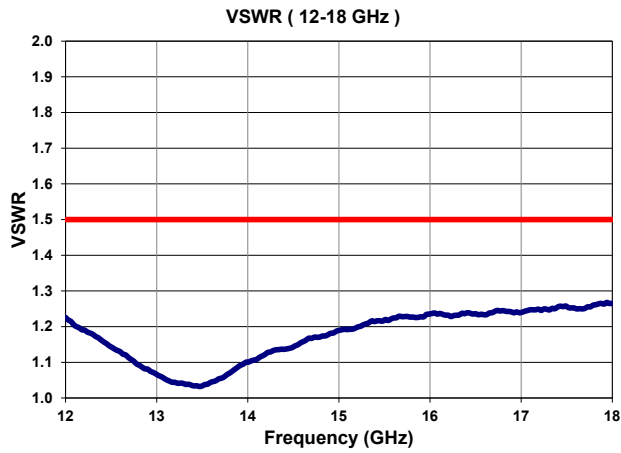
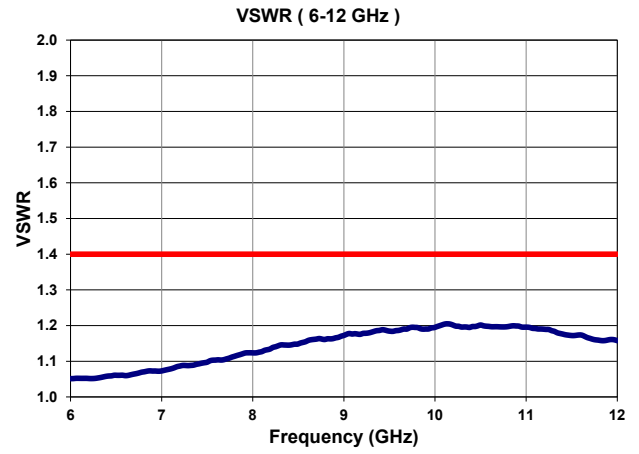
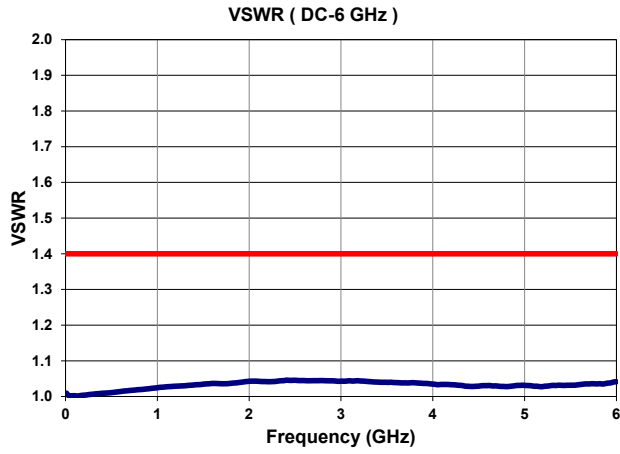

ELITE MODEL ONLY

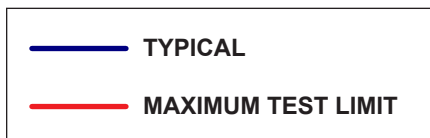

TYPICAL POWER PERFORMANCE CURVE

Power Handling vs. Frequency

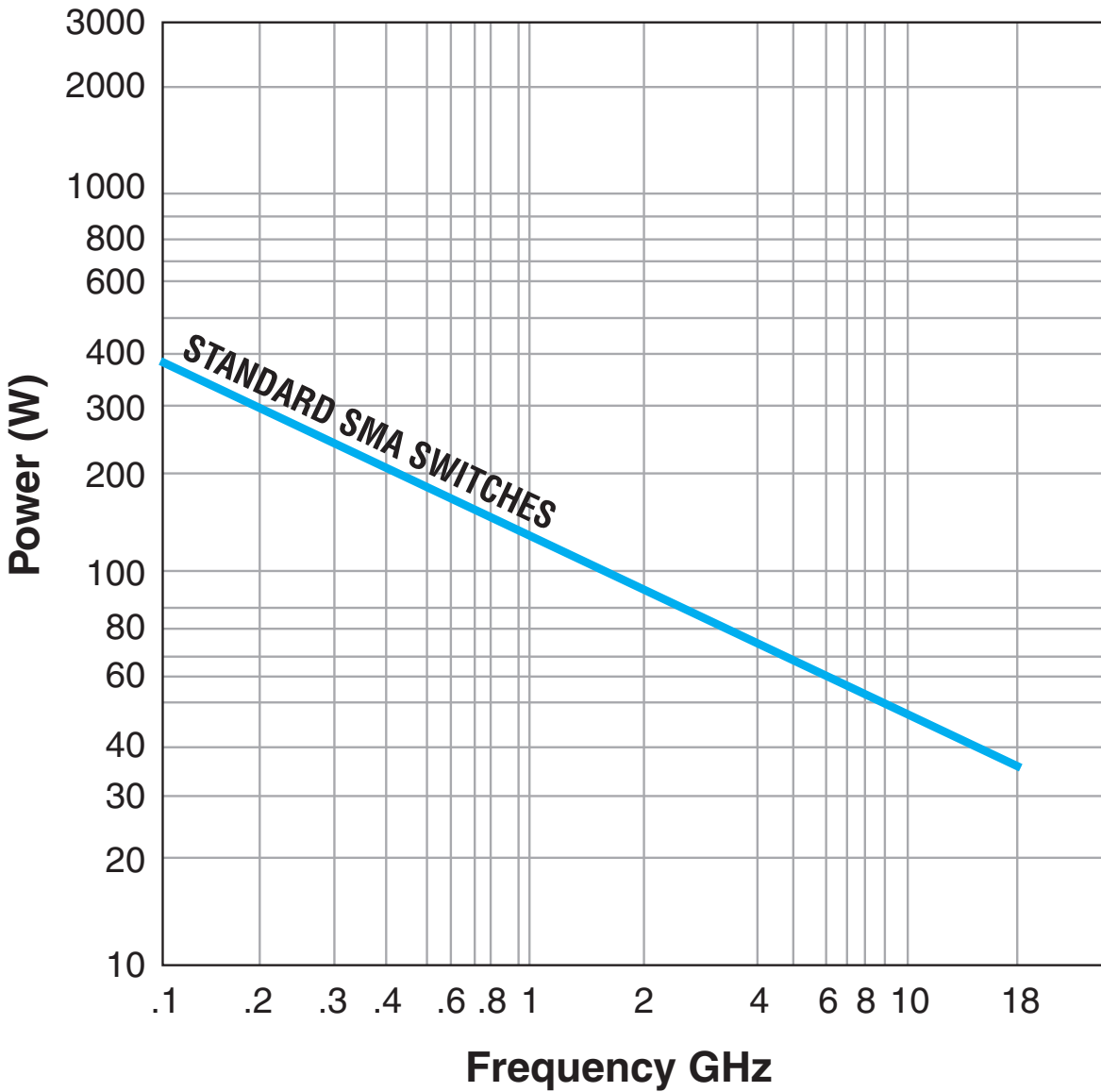

Estimates based on the following reference conditions:

- Ambient temperature of 40°C or less
- Sea level operation
- Load VSWR of 1.20:1 maximum
- No high-power (hot) switching

Please contact Teledyne Coax Switches for derating factors when applications do not meet the foregoing reference conditions.

GLOSSARY

Actuator

An actuator is the electromechanical mechanism that transfers the RF contacts from one position to another upon DC command.

Arc Suppression Diode

A diode is connected in parallel with the coil. This diode limits the “reverse EMF spike” generated when the coil de-energizes to 0.7 volts. The diode cathode is connected to the positive side of the coil and the anode is connected to the negative side.

Date Code

All switches are marked with either a unique serial number or a date code. Date codes are in accordance with MIL-STD-1285 Paragraph 5.2.5 and consist of four digits. The first two digits define the year and the last two digits define the week of the year (YYWW). Thus, 1032 identifies switches that passed through final inspection during the 32nd week of 2010.

Latching

A latching switch remains in the selected position whether or not voltage is maintained. This can be accomplished with either a magnetic or mechanical latching mechanism.

Indicator

Indicators tell the system which position the switch is in. Other names for indicators are telemetry contacts or tellback circuit. Indicators are usually a set of internally mounted DC contacts linked to the actuator. They can be wired to digital input lines, status lights, or interlocks. Unless otherwise specified, the maximum indicator contact rating is 30 Vdc, 50 mA, or 1.5 Watts into a resistive load.

Internal Termination

Unselected ports are internally terminated to a matched load. The load is 50Ω resistive device. The max RF power rating is 2 Watts CW. Without the internal termination option, the unselected ports are open circuits.

Isolation

Isolation is the measure of the power level at the output connector of an unconnected RF channel as referenced to the power at the input connector. It is specified in dB below the input power level.

Self-Cutoff

The self-cutoff option disables the actuator current on completion of actuation. Either a series contact (linked to the actuator) or an IC driver circuit provides the current cutoff. This option results in minimum power consumption by the RF switch. Cutthroat is another name used in the industry for this option. Pulse latching is a term used to describe a switch without this feature.

SPDT Switch

A single-pole double-throw, bi-directional switch that can be used as having one input and two outputs or two inputs and one output.

Switching Time

Switching time is the total interval beginning with the arrival of

the leading edge of the command pulse at the switch DC input and ending with the completion of the switch transfer, including contact bounce. It consists of three parts: (1) inductive delay in the coil, (2) transfer time of the physical movement of the contacts, and (3) the bounce time of the RF contacts.

TTL Switch Driver Option

As a special option, switch drivers can be provided for both failsafe and latching switches, which are compatible with industry-standard low-power Schottky TTL circuits.

Performance Parameters vs Frequency

Generally speaking, the RF performance of coaxial switches is frequency dependent. With increasing frequency, VSWR and insertion loss increase while isolation decreases. All data sheets specify these three parameters as “worst case” at the highest operating frequency. If the switch is to be used over a narrow frequency band, better performance can be achieved.

Actuator Current vs Temperature

The resistance of the actuator coil varies as a function of temperature. There is an inverse relationship between the operating temperature of the switch and the actuator drive current. For switches operating at 28 VDC, the approximate actuator drive current at temperature, T, can be calculated using the equation:

$$I_T = \frac{I_A}{[1 + .00385 (T-20)]}$$

Where:

I_T = Actuator current at temperature, T

I_A = Room temperature actuator current – see data sheet

T = Temperature of interest in °C

Magnetic Sensitivity

An electro-mechanical switch can be sensitive to ferrous materials and external magnetic fields. Neighboring ferrous materials should be permitted no closer than 0.5 inches and adjacent external magnetic fields should be limited to a flux density of less than 5 Gauss.

SPECIAL FEATURE

Switching High-Power or Highly Sensitive Signals

Ensure the most linear response with the best galvanically matched contact system in the industry. Extremely low passive intermodulation is standard on all of our switches.

Carrier Frequency 1	Carrier Frequency 2	PIM 3rd Order Frequency	PIM 5th Order Frequency
870 MHz	893 MHz	847 MHz	824 MHz

	3rd Order Intermodulation	5th Order Intermodulation
SPDT	–91 dBm	–110 dBm
	–134 dBc	–153 dBc

LATCHING CCRT-33S/CRT-33S PART NUMBER LIST

	PART No.		PART No.		PART No.
1	CCRT-33SXC	43	CCRT-33SX0	85	CRT-33SXD-MS
2	CCRT-33SXC-D	44	CCRT-33SX0-D	86	CRT-33SXD-R
3	CCRT-33SXC-DM	45	CCRT-33SX0-DM	87	CRT-33SXD-RM
4	CCRT-33SXC-DMS	46	CCRT-33SX0-DMS	88	CRT-33SXD-RMS
5	CCRT-33SXC-DR	47	CCRT-33SX0-DR	89	CRT-33SXD-RS
6	CCRT-33SXC-DRM	48	CCRT-33SX0-DRM	90	CRT-33SXD-S
7	CCRT-33SXC-DRMS	49	CCRT-33SX0-DRMS	91	CRT-33SXD-T
8	CCRT-33SXC-DRS	50	CCRT-33SX0-DRS	92	CRT-33SXD-TM
9	CCRT-33SXC-DS	51	CCRT-33SX0-DS	93	CRT-33SXD-TMS
10	CCRT-33SXC-M	52	CCRT-33SX0-M	94	CRT-33SXE
11	CCRT-33SXC-MS	53	CCRT-33SX0-MS	95	CRT-33SXE-M
12	CCRT-33SXC-R	54	CCRT-33SX0-R	96	CRT-33SXE-MS
13	CCRT-33SXC-RM	55	CCRT-33SX0-RM	97	CRT-33SXE-R
14	CCRT-33SXC-RMS	56	CCRT-33SX0-RMS	98	CRT-33SXE-RM
15	CCRT-33SXC-RS	57	CCRT-33SX0-RS	99	CRT-33SXE-RMS
16	CCRT-33SXC-S	58	CCRT-33SX0-S	100	CRT-33SXE-RS
17	CCRT-33SXC-T	59	CCRT-33SX0-T	101	CRT-33SXE-S
18	CCRT-33SXC-TM	60	CCRT-33SX0-TM	102	CRT-33SXE-T
19	CCRT-33SXC-TMS	61	CCRT-33SX0-TMS	103	CRT-33SXE-TM
20	CCRT-33SXC-TS	62	CCRT-33SX0-TS	104	CRT-33SXE-TMS
21	CCRT-33SXD	63	CRT-33SXC	105	CRT-33SX0
22	CCRT-33SXD-M	64	CRT-33SXC-D	106	CRT-33SX0-D
23	CCRT-33SXD-MS	65	CRT-33SXC-DM	107	CRT-33SX0-DM
24	CCRT-33SXD-R	66	CRT-33SXC-DMS	108	CRT-33SX0-DMS
25	CCRT-33SXD-RM	67	CRT-33SXC-DR	109	CRT-33SX0-DR
26	CCRT-33SXD-RMS	68	CRT-33SXC-DRM	110	CRT-33SX0-DRM
27	CCRT-33SXD-RS	69	CRT-33SXC-DRMS	111	CRT-33SX0-DRMS
28	CCRT-33SXD-S	70	CRT-33SXC-DRS	112	CRT-33SX0-DRS
29	CCRT-33SXD-T	71	CRT-33SXC-DS	113	CRT-33SX0-DS
30	CCRT-33SXD-TM	72	CRT-33SXC-M	114	CRT-33SX0-M
31	CCRT-33SXD-TMS	73	CRT-33SXC-MS	115	CRT-33SX0-MS
32	CCRT-33SXE	74	CRT-33SXC-R	116	CRT-33SX0-R
33	CCRT-33SXE-M	75	CRT-33SXC-RM	117	CRT-33SX0-RM
34	CCRT-33SXE-MS	76	CRT-33SXC-RMS	118	CRT-33SX0-RMS
35	CCRT-33SXE-R	77	CRT-33SXC-RS	119	CRT-33SX0-RS
36	CCRT-33SXE-RM	78	CRT-33SXC-S	120	CRT-33SX0-S
37	CCRT-33SXE-RMS	79	CRT-33SXC-T	121	CRT-33SX0-T
38	CCRT-33SXE-RS	80	CRT-33SXC-TM	122	CRT-33SX0-TM
39	CCRT-33SXE-S	81	CRT-33SXC-TMS	123	CRT-33SX0-TMS
40	CCRT-33SXE-T	82	CRT-33SXC-TS	124	CRT-33SX0-TS
41	CCRT-33SXE-TM	83	CRT-33SXD		
42	CCRT-33SXE-TMS	84	CRT-33SXD-M		

* X = 6 (28Vdc), 7 (15Vdc), 8 (12Vdc) and 9 (24Vdc)